

TELEPHONE TYPE INTERCOM TB-F SERIES

MODELS TB-1F (*single-way*) TB-3F (*three-way*)
 TB-6F (*six-way*) TB-12F (*twelve-way*)
COMMON TALK **SELECTIVE RING**

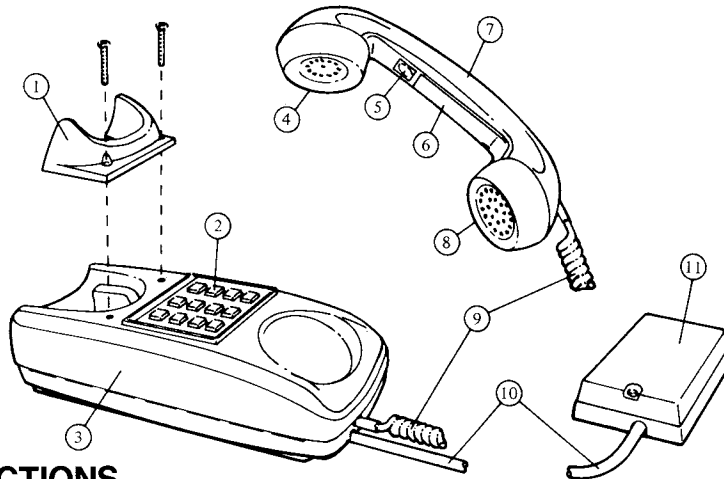

— INSTRUCTIONS —



NAMES AND FUNCTIONS

- | | |
|---|-----------------|
| ① Receiver cradle for wall mounting, included | ⑦ Handset |
| ② Station selector buttons | ⑧ Microphone |
| ③ Case | ⑨ Coil cord |
| ④ Receiver | ⑩ Terminal cord |
| ⑤ Paging button | ⑪ Terminal box |
| ⑥ Directory card | |

SPECIFICATIONS

- * Power source: DC 12 volt. Use PS-12A (PS-12C in North America) AC adaptor. If your system does not include door station or paging system, you may use PS-12S AC adaptor.
- * Current consumption: 70 mA maximum per station.
- * Calling: Push-button station selection. An electronic tone sounds when the selected station button is depressed.
- * Paging: Use PB-1 paging adaptor in conjunction with standard paging amplifier and speakers.
- * Wiring: Up to 17 conductors may be required. Please refer to wiring diagram showing system that meets your requirements.

BEFORE YOU INSTALL AND OPERATE THE EQUIPMENT — Prohibitions and precautions —

- * Operation;
 1. **DO NOT HOLD HOOK SWITCH DOWN WHILE PICKING UP HANDSET. THE CALL TONE SOUNDS THRU THE HANDSET RECEIVER ELEMENT AND COULD CAUSE HEARING DAMAGE.**
- * Installation;
 1. **DO NOT CONNECT ANY TERMINAL ON ANY UNIT TO AC POWER LINES.**
 2. Be sure to remove plug of power supply from AC outlet before you open the unit or make wiring connections.
 3. Avoid running the connecting wires thru doors, windows or between furniture, which may pinch and disconnect the wires.
 4. The intercom equipment must be installed in as dry and dust-free environment as possible.
- * Maintenance;
 1. Clean your intercom equipment with a soft cloth dampened with neutral household cleanser. Never use thinner nor benzine, etc.
 2. Do not splash water on the door station by hose, etc.

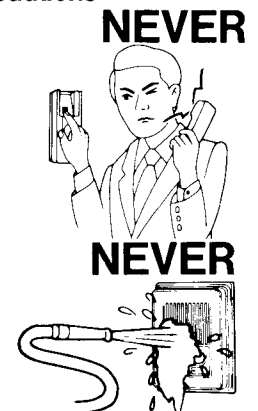



















FEATURES

- * Up to 13 stations can be connected in a system.
- * Common talk system for phone communication. (Conference calls can selectively include up to 6 stations)
- * Separate paging channel. Paging announcement may be done separately and independently from phone communication.
- * ECM (Electret condenser mic) provides excellent voice fidelity.
- * Phone designed for either desk use or wall mounting. Terminal cord may be pulled out from either the top or the bottom of the phone.

OPTIONS

- * Door station IC-DC can be installed with adaptor DB-U. Up to two door stations may be connected to a maximum of 12 phones.
- * One call sub station TB-A is available where paging or door station communication is not required (TB-A is designed for wall mounting only).
- * Phone system may be connected to existing paging and background music system using adaptor PB-1.
- * Talkback paging available through existing paging system using adaptor PB-2 in conjunction with PB-1.
- * A call in a noisy area may be annunciated by a separate buzzer or bell using the RY-AC relay.

EQUIPMENT AVAILABLE FOR USE WITH YOUR TB-F PHONE SYSTEM

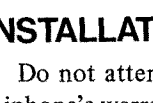
	TB-1F: 1 call master station with paging button (will not work with door station).		SP-3: Paging speaker. Complete and ready to install including round flush mounting frame.
	TB-3F: 3 call master station with paging button and door station capability.		NCH-2: Noise-resistant handset. For field installation only.
	TB-6F: 6 call master station with paging button and door station capability.		RY-SP: Local speaker cutout relay.
	TB-12F: 12 call master station with paging button and door station capability.		RY-AC: Relay for operating external device such as additional calling buzzer or bell, door release, etc.
	TB-A: 1 call sub station without paging or door station capability. Wall mounting only (not available in U.S.A.).		EL-9S: Electric door release. Requires separate transformer and RY-AC.
	IC-DC: Surface mount standard door station.		PS-12C: CSA & UL Listed power supply (available only in North America).
	DB-U: Adaptor for door station. Requires between one door station and TB-F phones.		PS-12A: Power supply. Standard everywhere except North America.
	PB-1: Paging adaptor. Connects all TB-F phones to a paging system and background music source.		PS-12S: Power supply. May be used in a TB-F system which does not include door station or paging system (not available in North America).
	PB-2: Paging adaptor with talkback. Must be used in conjunction with PB-1.		PG-3: 3-watt paging amplifier.
	PG-10A, PG-30A, PG-60A: UL & CSA approved paging amplifier. 10W, 30W, 60W (available only in North America).		
	PG-10B, PG-30B, PG-60B: Standard paging amplifier. 10W, 30W, 60W.		

INSTALLATION

Do not attempt to install your intercom system until you have read and thoroughly understood the installation procedure. Aiphone's warranty is void if system is installed in a manner other than described in this manual.

Lay out your system in advance. Determine the exact location of each station. We recommend a full complement of wire be installed, even though you may not initially be installing the maximum number of stations available to your system. This way, should you decide to add a station later, you can avoid running additional cables to existing stations.

WIRING REQUIRED

TB-1F: 5 Conductors maximum
 TB-3F: 8 Conductors maximum

TB-6F: 11 Conductors maximum
 TB-12F: 17 Conductors maximum

Refer to the chart below and select the proper wire gauge to meet your requirements.

AWG WIRE SIZE	24 AWG	22 AWG	20 AWG
MAXIMUM COMMUNICATION DISTANCE BETWEEN MOST DISTANT PHONES	1200'	2000'	3000'
MAXIMUM COMMUNICATION DISTANCE FROM PHONE TO DOORS STATION	300'	500'	700'

DIAMETER OF WIRE	0.5 mm	0.65 mm	0.8 mm
MAXIMUM COMMUNICATION DISTANCE BETWEEN MOST DISTANT PHONES	400 m	650 m	1000 m
MAXIMUM COMMUNICATION DISTANCE FROM PHONE TO DOOR STATION	90 m	150 m	230 m

Begin your installation with station #1. A space is provided at the left of the diagram to write in your color code. Note the position of the C terminal at each station. Be sure you wire each station correctly.

After installing your second station we recommend that the power supply be connected to the ⊕ and ⊖ terminal lines at a convenient location and that a test be made for calling and talking between each station. As each additional station is installed re-test between each station. Unplug power supply while making wiring connections.

ACTUAL TB-F TERMINAL LOCATIONS

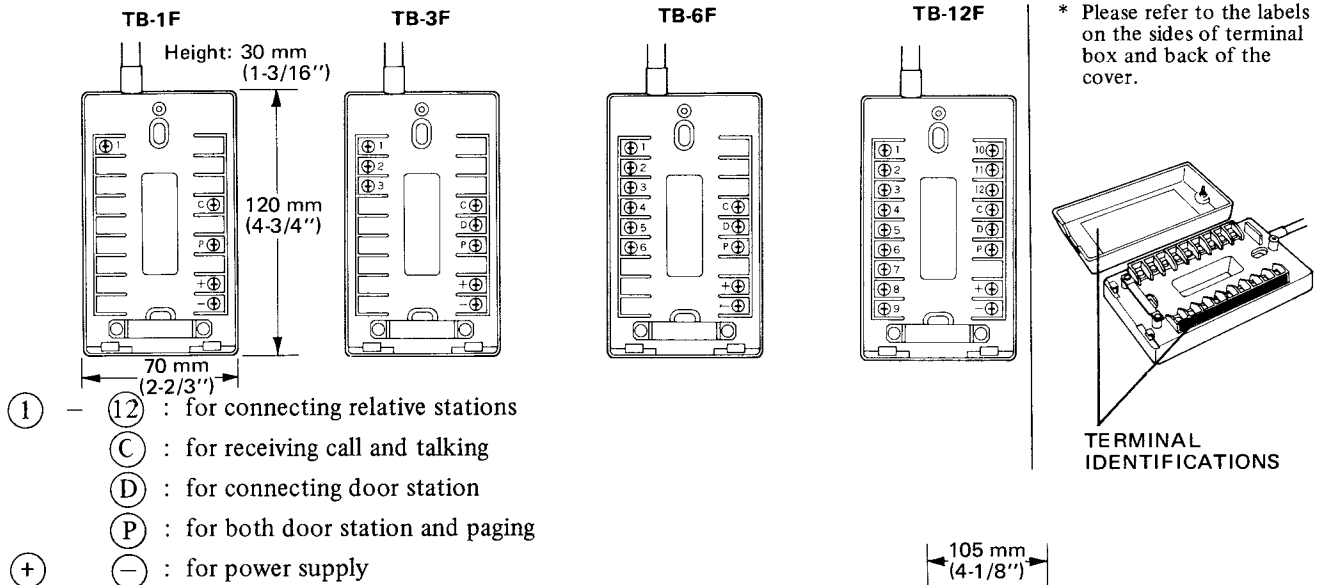

INSTALLATION FOR WALL MOUNTING

- 1) Attach the mounting bracket to wall or single gang plaster ring.
- 2) Attach handset cradle included, as shown in illustration.

NOTE: Terminal cord may be pulled out from either the top or the bottom of the body, or straight back to plaster ring.

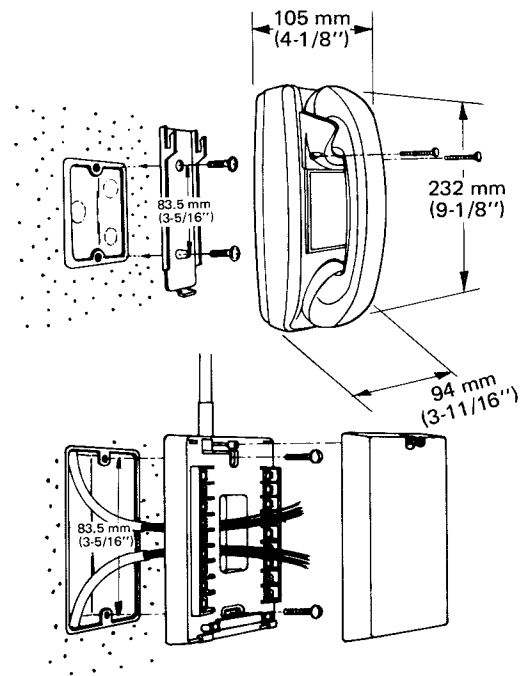

INSTALLATION OF TERMINAL BOX

(Can be mounted easily to wall or single gang box.)

- 1) Remove screws and cover as shown.
- 2) Attach bottom case to wall or 1-gang box.
- 3) Replace cover after wiring.

TB-12F ALL MASTE

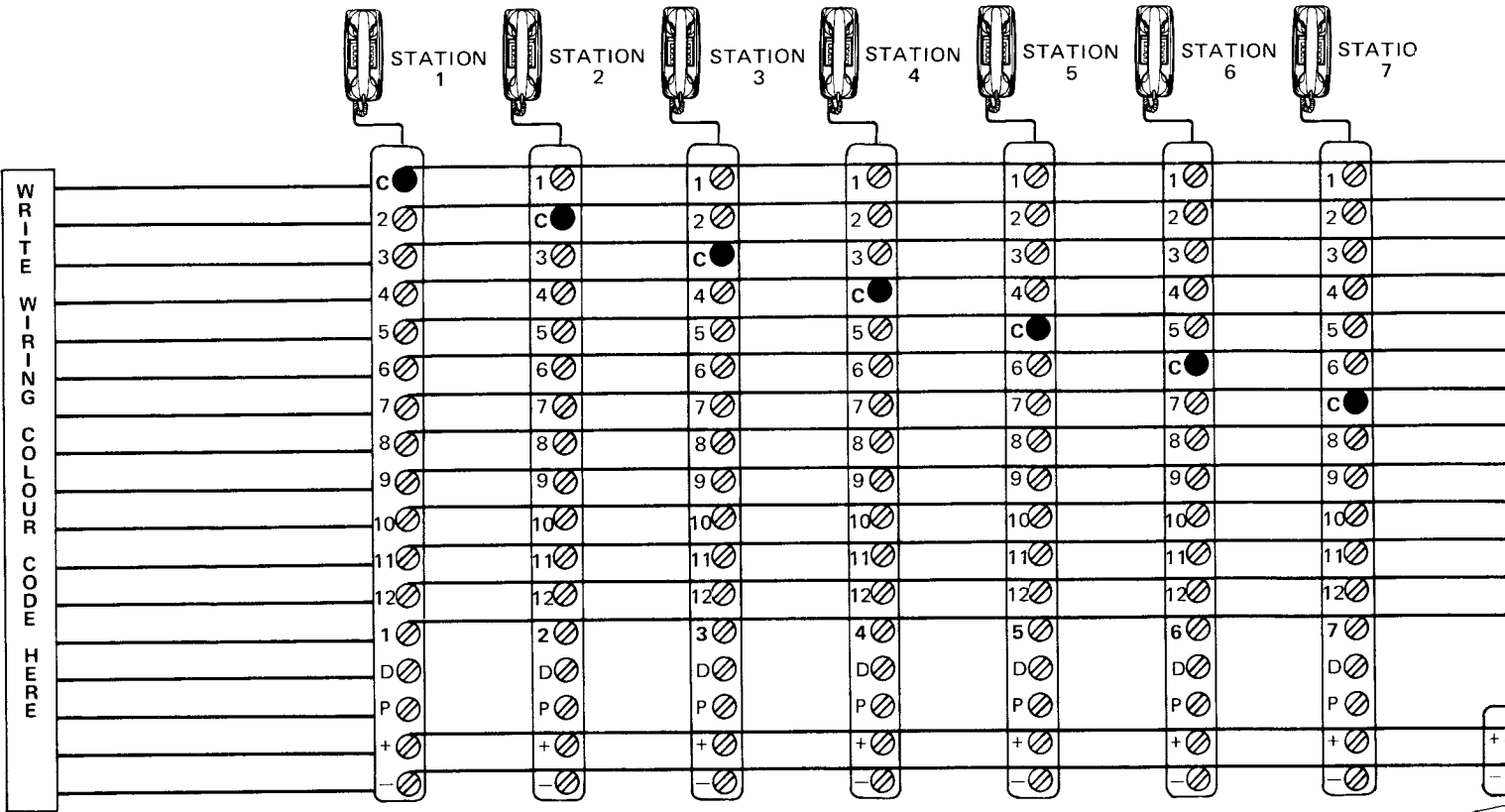

TB-12F PHONE SYSTEM with PAGING

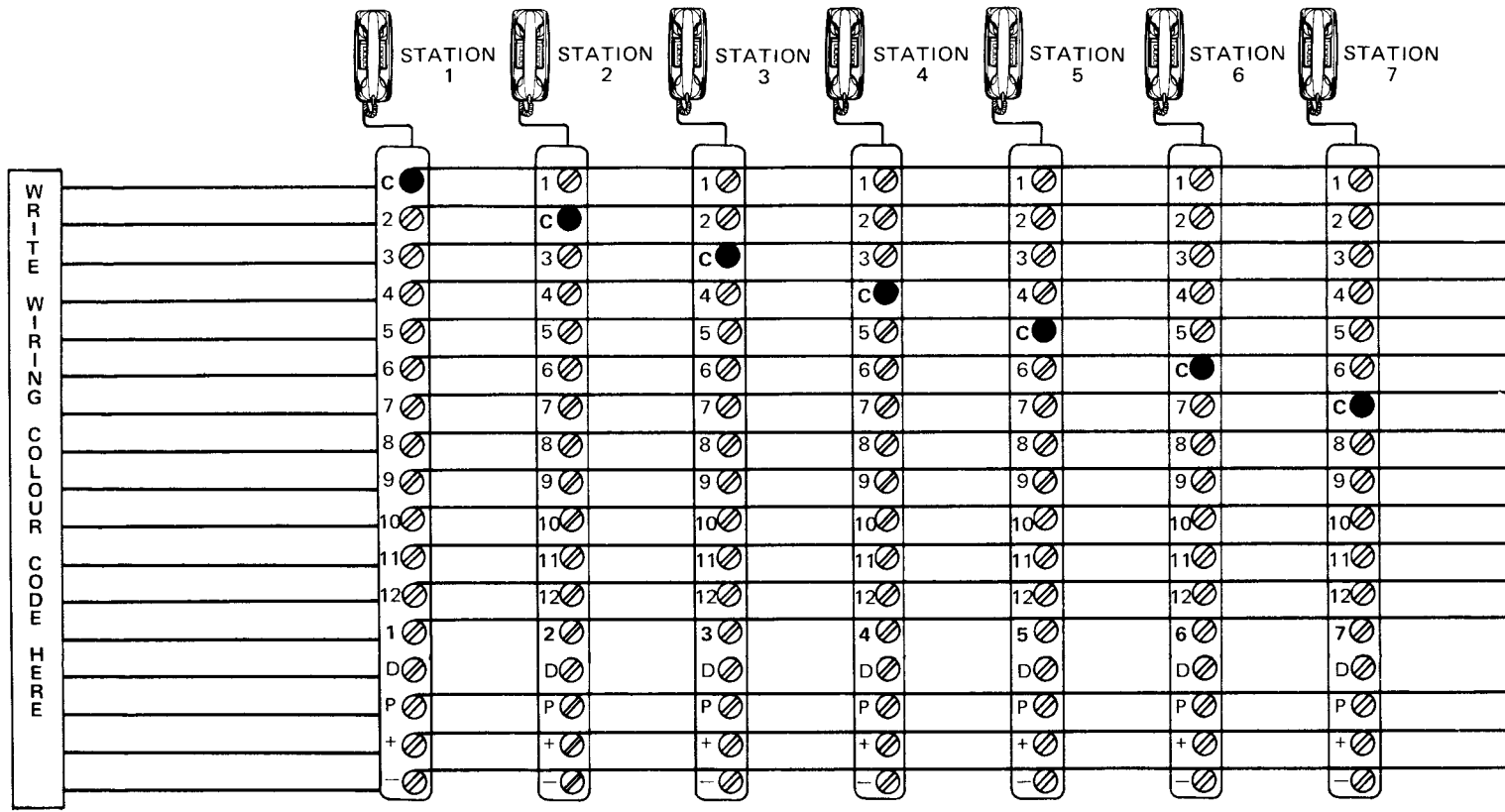

R PHONE SYSTEM

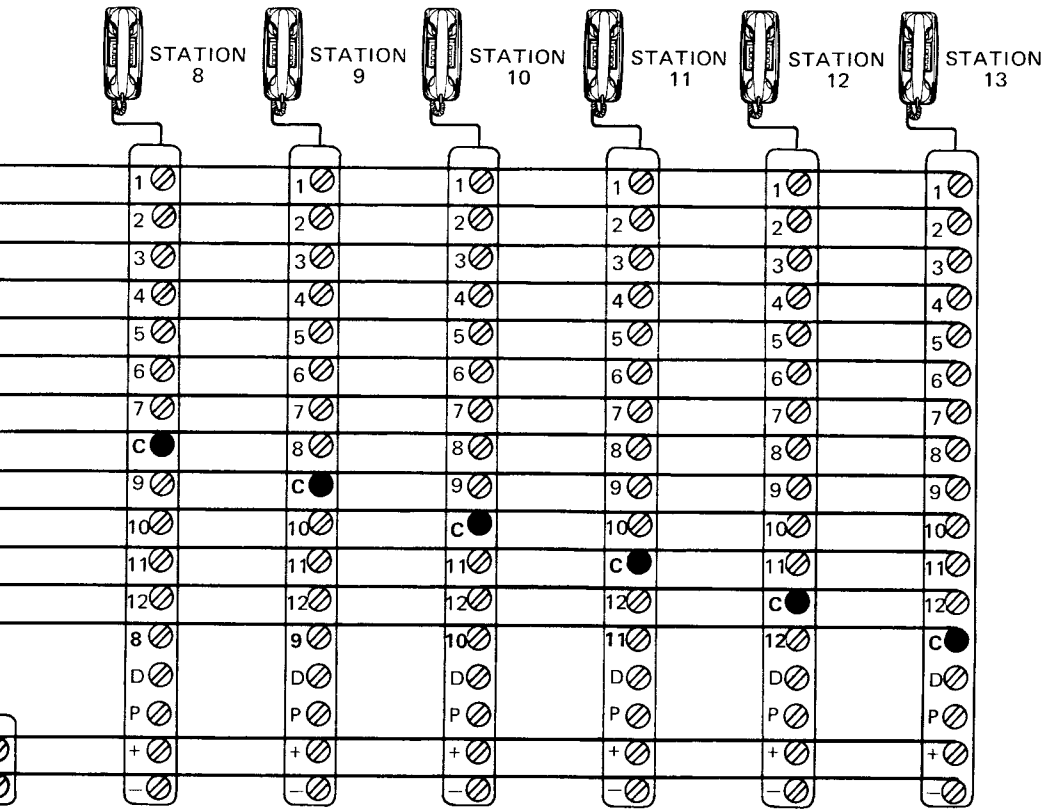

* Place PS-12A (or PS-12C) power supply near the center of the system.

and BACKGROUND MUSIC SYSTEM

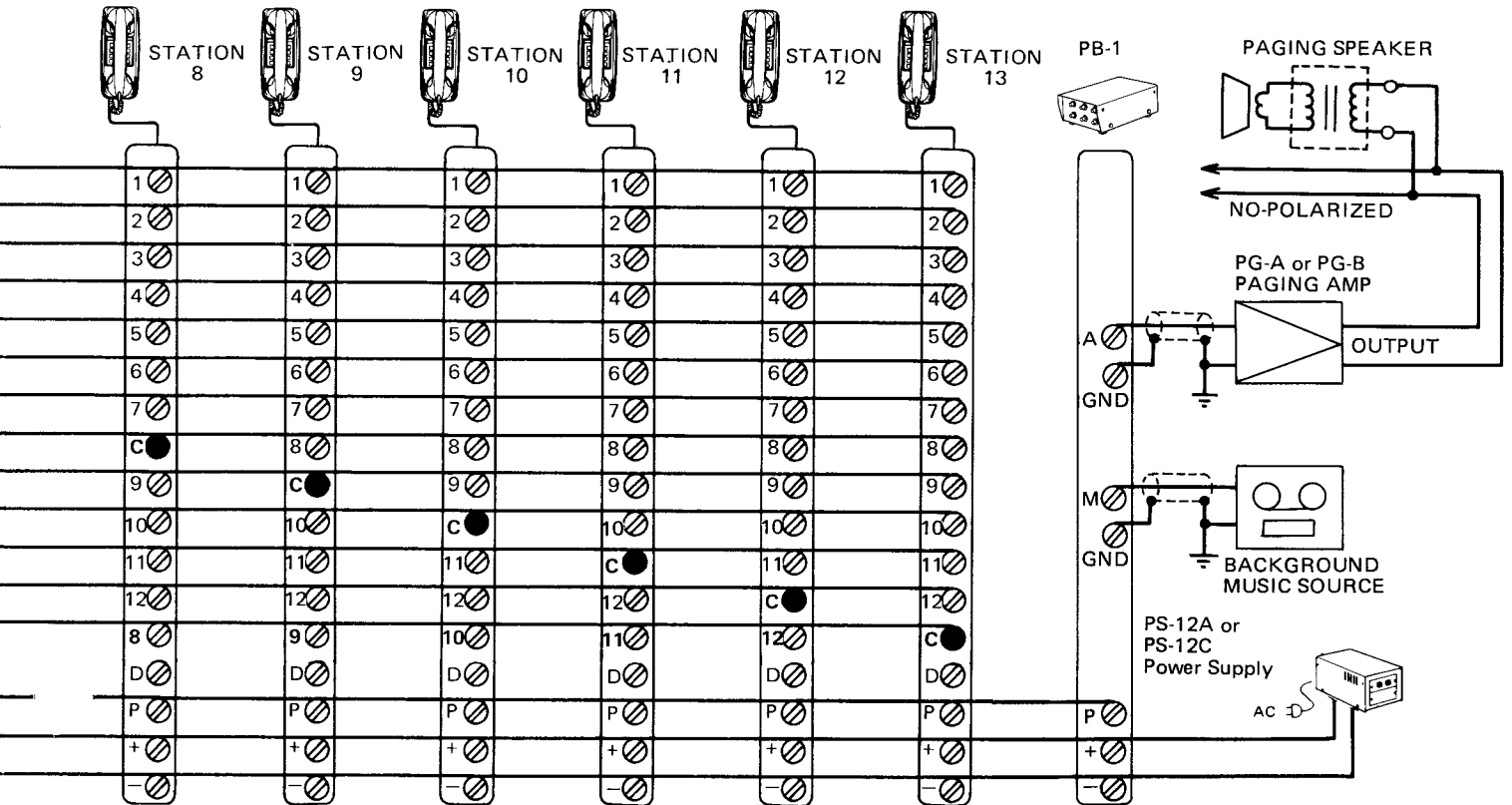

* PB-1 paging adaptor must be connected directly to PS-12A (or PS-12C) power supply.

VARIATIONS TO STANDARD INSTALLATIONS

Any combination of TB-F series phones and accessories shown on page 2 of this manual can be intermixed to develop a communication system to meet your requirements. Installation examples below show TB-6F as master station which may be replaced by either TB-3F or TB-12F.

EXAMPLE NO. 1: TB-F SYSTEM WITH ONE MASTER AND SEVERAL SUBS

- 1) This example shows six TB-1F phones connected to one TB-6F.
- 2) Paging system may be added using PB-1 adaptor.

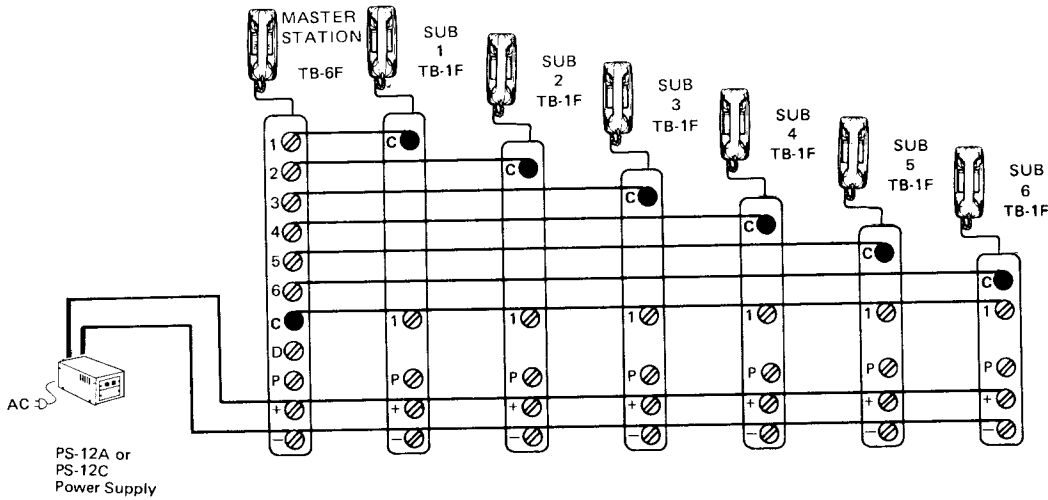

EXAMPLE NO. 2: TB-F SYSTEM WITH TALKBACK PAGING

EQUIPMENT REQUIREMENTS

- 1) TB-F system shall consist of TB-1F, TB-3F, TB-6F or TB-12F phones.
- 2) One PS-12A (or PS-12C), one PB-1, one PB-2, one paging amplifier with 70 or 100 volt line and output of less than 50 watt RMS, and appropriate paging speakers as required must be used.
- 3) Door station may be included in system with paging or talkback paging.

NOTE: * PB-1 and PB-2 paging adaptors must be connected directly to PS-12A (or PS-12C) power supply.
 * For full information please refer to PB-2 instruction sheet.

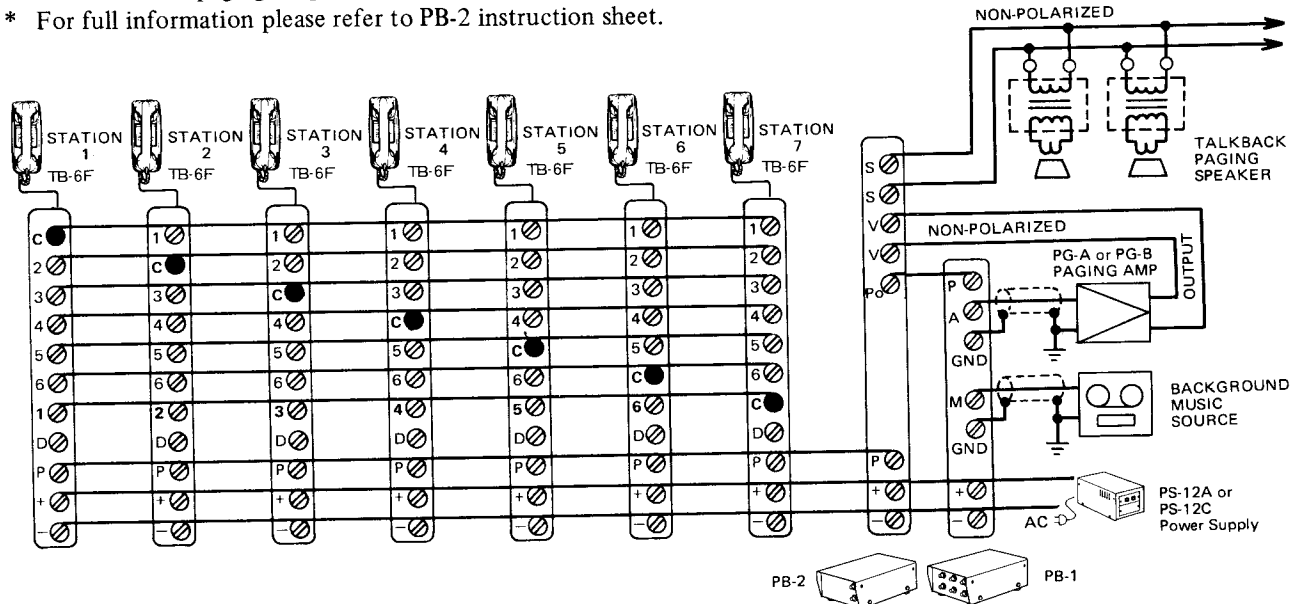

EXAMPLE NO. 3: TB-F SYSTEM WITH 2 DOOR STATIONS AND ELECTRIC DOOR RELEASE

- Maximum of 2 door stations may be connected to up to 12 phones per system.

NOTES: (1) DB-U door station adaptor must be connected directly to PS-12A (PS-12C) power supply.

(2) Be sure to connect **D** and **P** terminals on each phone for communication with door station (paging may be added in a system incorporating door station).

(3) Do not use #1 terminal on any TB-F phone for connecting CF terminal on DB-U.

In this example button #5 allows conversation with door station #①, button #6, with door station #② and each station number button operates door release.

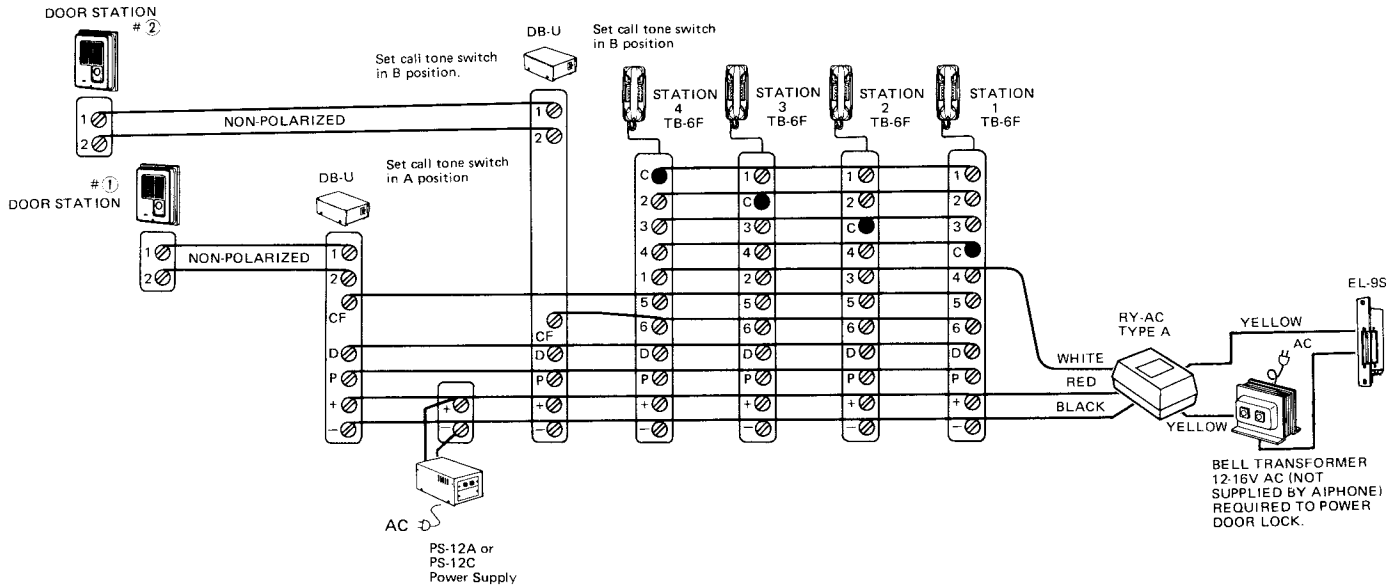

* PLEASE SELECT THE MOST SUITABLE DOOR STATION FOR YOUR APPLICATION:



IC-DC



IC-NA



IC-RA



IC-KA

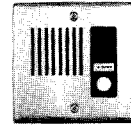

IC-JA

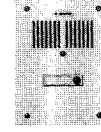

IC-FY

EXAMPLE NO. 4: TB-F SYSTEM WITH EXTERNAL SIGNALING DEVICE

1) When TB-F phone is located in very noisy area (station No. 7 in this example), an incoming call may be extended by external signaling device such as bell or buzzer using RY-AC.

2) External signaling device (not supplied by Aiphone) should not exceed 0.3A 240V AC or 1.0A 24V DC.

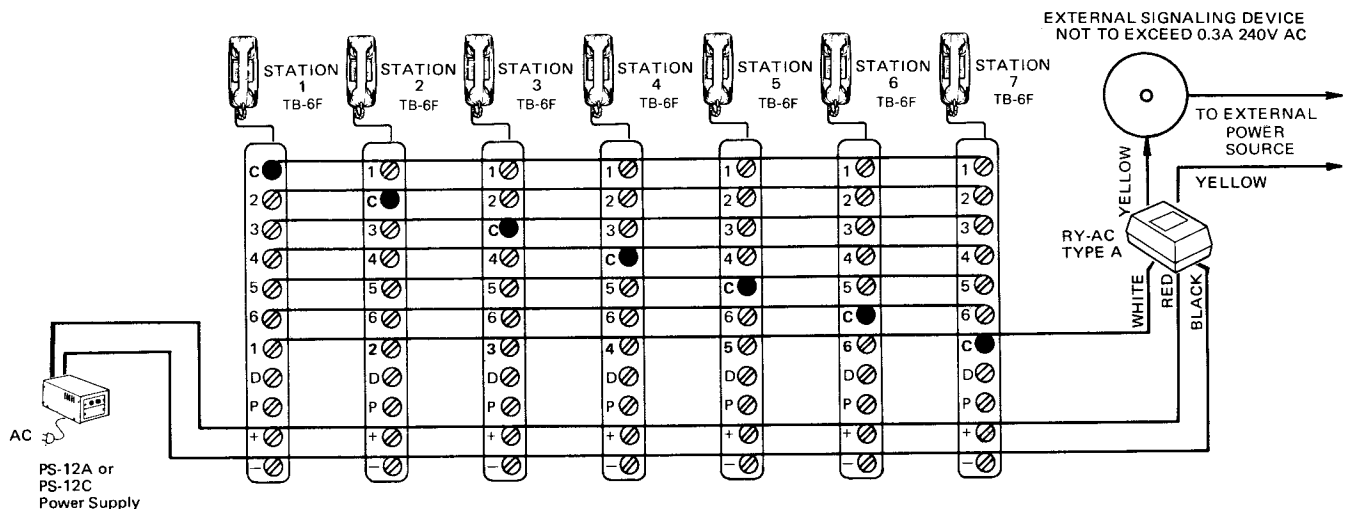

OPERATION

CALLING:

Pick up the handset and momentarily depress the selector button of desired station.

RECEIVING:

An incoming call is announced by an electronic tone. Pick up the handset and begin speaking. When called from door, pick up the handset, press the selector button corresponding to door station and begin speaking.

NOTE: Do not depress paging button while talking with other phone. When pressed it will cut phone communication or, if paging system is installed, your voice will be broadcast over paging speakers.

PAGING:

Pick up the handset and make announcement by pushing and holding the paging button. Background music will automatically cut out during paging operation.

TALKBACK PAGING:

Depress the paging button for announcement and release for talkback.

NOTE: Talkback paging must be made with no phone-to-phone communication present since distortion will occur.

We at AIPHONE are proud of our products. Our designers and engineers strive to bring you the finest in communication equipment. Each item has been carefully tested and inspected before leaving our factory. Properly installed and used, your Aiphone intercom system should give years of trouble-free service.

We are pleased to offer the following warranty:

WARRANTY

Aiphone warrants its products to be free from defects of material and workmanship under normal use and service for a period of one year after delivery to the ultimate user and will repair free of charge or replace at no charge, should it become defective upon which examination shall disclose to be defective and under warranty. Aiphone reserves unto itself the sole right to make the final decision whether there is a defect in materials and/or workmanship; and whether or not the product is within the warranty.

This warranty shall not apply to any Aiphone product which has been subject to misuse, neglect, accident, or to use in violation of instructions furnished, nor extended to units which have been repaired or altered outside of the factory.

This warranty does not cover batteries or damage caused by batteries used in connection with the product.

This warranty covers bench repairs only, and any repairs must be made at the shop or place designated in writing by Aiphone. Aiphone will not be responsible for any costs incurred involving on site service calls.

Aiphone Co., Ltd., Nagoya, Japan
Aiphone Corporation, Bellevue, Washington

TB-F-I-0986 Ⓚ

INTERCOM SYSTEMS
AIPHONE
HOME, BUSINESS, INDUSTRY

Printed in Japan (E)